



SVK
& SVS
AUDIO
SERIES
MULTIPIN
CONNECTORS

syntax
no compromise

SVK AUDIO 13 - 19 - 25 - 37 - 54 - 72 - 85 - 100 - 101 - 150 PIN & SVS

INLINE FEMALE



The new **SYNTAX® SVK** audio series has been conceived and manufactured to set a higher standard for studio applications. Its IP67 waterproof rating makes it perfectly suitable also for outdoor applications. **SVS** Slim High-Density series is also available (72 and 101 pin configurations). **SVK** audio and **SVS** Slim High Density series are compliant with military standard Mil C 5015 & VG 95234. Compared to our previous standard audio series, the new SVK has been enhanced to achieve a higher level of robustness and durability.



Special aluminium alloy shell with high-resistance black finish.

Pic. 1 - Marked knurling on the whole circumference of locking-ring for optimal grip and easy coupling. An audible click indicates that locking is complete.

Pic. 2 - Thick wall construction locking-ring for greater resistance to all possible forms of abuse.

Pic. 3 - The aluminium housing for the neoprene insert is flush with the edge of locking-ring, so to avoid ovalization due to accidental blows.

Pic. 4 - Extra wide backshell for easier wiring.

Increased size of Coupling roller pins on locking-ring for more durability.

SVK AUDIO 13 - 19 - 25 - 37 - 54 - 72 - 85 - 100 - 101 - 150 PIN & SVS

INLINE MALE



Many of its features have been borrowed from the bigger SHD Roadline series, such as a thicker locking ring with deeper knurling for maximum ease of coupling and a thicker backshell. The new aluminium locking ring also features coupling roller pins and, just like on the SHD series, the locking ring is designed in such a way to prevent possible ovalization of the insert due to accidental blows. Protective dust caps are available. They are provided with a special high-resistance cable lacing made up of seven stainless strands, covered by an anti-abrasion Teflon black tube.

SVK audio is available in 13, 19, 25, 37, 54, 85, 100 and 150 pin configurations.

SVS Slim High-Density series is available in 72 and 101 pin configurations.

DUST CAP FOR IP67 WHEN MATED



SVK AUDIO 13 - 19 - 25 - 37 - 54 - 72 - 85 - 100 - 101 - 150 PIN & SVS











PANEL FEMALE



PANEL MALE

CONTACTS

CRIMP CONTACTS TYPES AND PART N.

Size	Connector	Plating	Part N.	Gender	Part N.	Gender
16	13/19/25/37/54/85 pin	Silver	SVKP16SFC	Female	SVKP16SMC	Male
						
		Gold	SVKP16GFC	Female	SVKP16GMC	Male
						
18	100/150 pin	Gold	SVKP18GFC	Female	SVKP18GMC	Male
						
20	72/101 pin	Gold	SVKP20GFC	Female	SVKP20GMC	Male
						

SOLDER CONTACTS TYPES AND PART N.

Size	Connector	Plating	Part N.	Gender	Part N.	Gender
16	13/19/25/37/54/85 pin	Gold	SVKP16GFS	Female	SVKP16GMS	Male
						

CONTACTS RATING

Size	Max Current	Rated Current	Max Voltage Drop	Wire section (mm ²)	Wire section AWG
16	22 A	13 A	74 mv	1+1,5	18+16
18	10 A	7,5 A	83 mv	0,15+0,6	26+20
20	7,5 A	7,5 A	83 mv	0,15+0,3	26+22

CONNECTORS RATING

Contacts number	Operating voltage		Test voltage	Min. Flashover
	Vdc	Vac	Vac	Vac
13/19/25/150 - 72/101	250	200	1000	1400
37/54/85/100	700	500	2000	2800

OVERALL SIZE

CUT-OUT DIMENSIONS

PANEL FEMALE

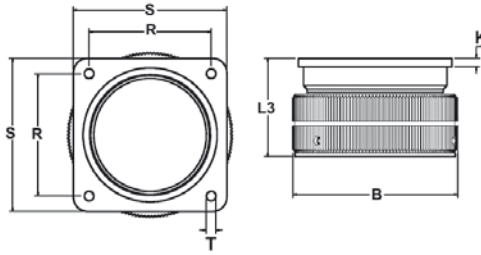

N° pin	shell size	BØ Max	L3	K	R	S	T
			Max	±0.2	±0.1	±0.3	H13
13 - 19	20	43.0	38.1	4	29.4	38.0	3.2
25	24	50.4	40.6	4	34.9	44.5	3.7
37-72	28	56.0	40.8	4	39.7	50.8	3.7
54-101	32	63.0	43.7	4	44.45	57.0	4.4
85-100-150	40	75.0	44.8	4	55.6	69.8	4.4

PANEL MALE

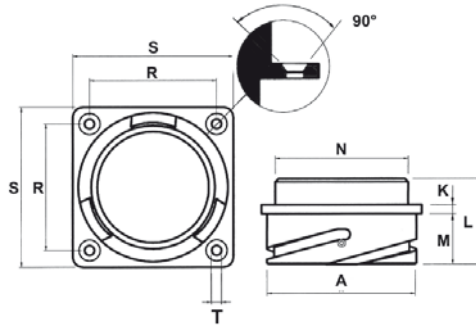

N° pin	shell size	AØ	K	L	M	ØN	R	S	T
		+0/-0.15	±0.2	±0.3	±0.4/-0	Max	±0.1	±0.3	H13
13 - 19	20	34.2	4	34.5	19	31.75	29.4	38.1	3.2
25	24	40.9	4	35.7	20.6	35.3	34.9	44.5	3.7
37-72	28	46.7	4	35.7	20.6	41.4	39.7	50.8	3.7
54-101	32	53.4	4	37.3	22.2	47.8	44.5	57	4.3
85-100-150	40	65.5	4	37.3	22.2	59	55.6	69.8	4.3

INLINE FEMALE

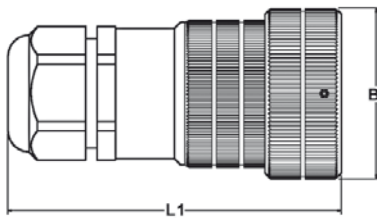

N° pin	shell size	BØ Max	L1 Max	Cable clamp Metric	Ø cable Min.-Max.
13 - 19	20	43.0	103	M 20	6 - 14
25	24	50.4	108	M 25	6 - 18
37-72	28	56.0	116	M 32	7 - 25
54-101	32	63.0	121	M 32	7 - 25
85 - 100 - 150	40	75.0	147	M 40	15 - 32

INLINE MALE

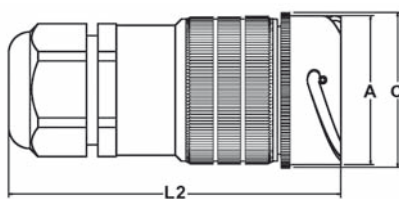

N° pin	shell size	AØ Max	ØC	L2 Max	Cable clamp Metric	Ø cable Min.-Max.
		+0/-0.15	Max			
13 - 19	20	40.0	43	102	M 20	6 - 14
25	24	40.9	44	109	M 25	6 - 18
37-72	28	46.7	50	116	M 32	7 - 25
54-101	32	53.4	56	122	M 32	7 - 25
85 - 100 - 150	40	65.5	69	147	M 40	15 - 32

13/19 pin

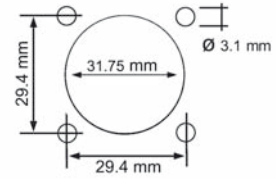

25 pin

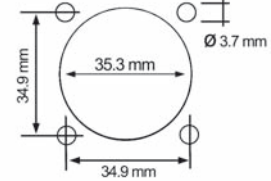

37/72 pin

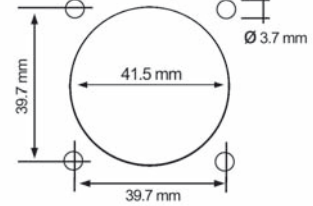

54/101 pin

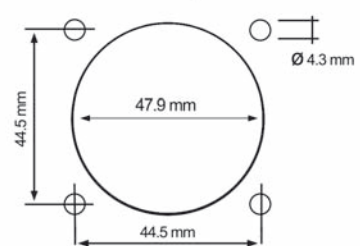

85/100/150 pin

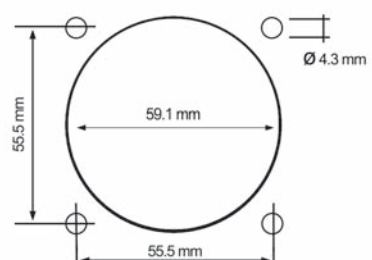

INSERT LAYOUTS AND WIRING LIST

FRONT VIEW OF MALE INSERT

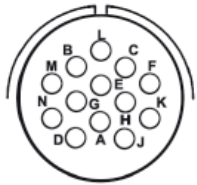

13 pin / size 20

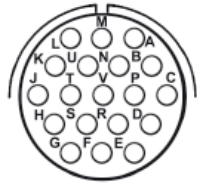

19 pin / size 20

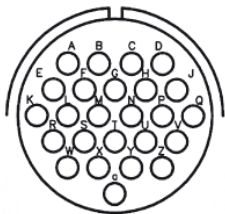

25 pin / size 24

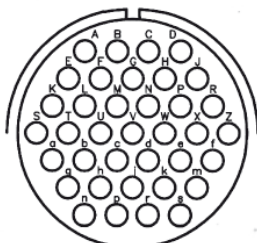

37 pin / size 28

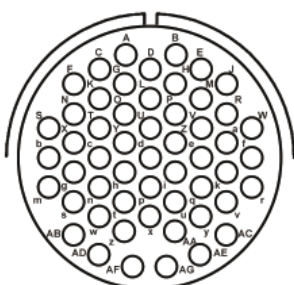

54 pin / size 32

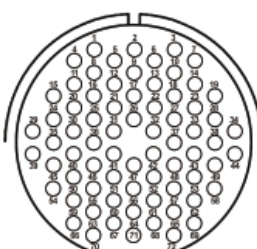

72 pin / size 28

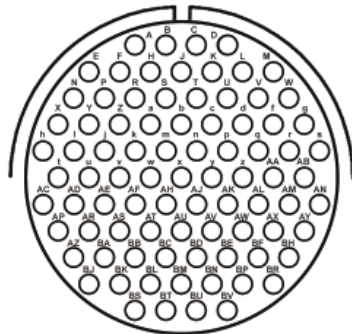

85 pin / size 40

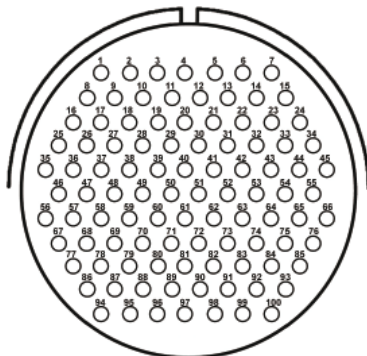

100 pin / size 40

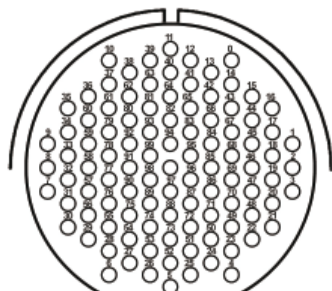

101 pin / size 32

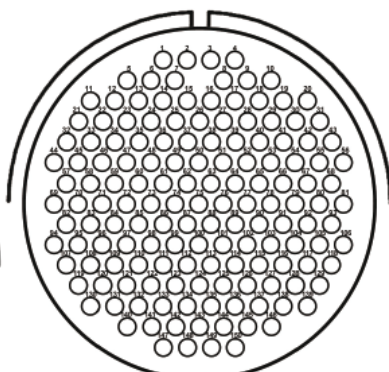

150 pin / size 40

13 pin - 4 channels			
Ch	Hot	Cold	Gnd
No.	+	-	⏏
1	M	B	L
2	N	G	E
3	D	A	H
4	J	K	F

19 pin - 6 channels			
Ch	Hot	Cold	Gnd
No.	+	-	⏏
1	A	M	L
2	C	P	B
3	N	U	V
4	T	J	K
5	D	R	E
6	F	G	S

25 pin - 8 channels			
Ch	Hot	Cold	Gnd
No.	+	-	⏏
1	A	E	F
2	G	C	B
3	D	H	J
4	M	L	K
5	Q	P	N
6	W	S	R
7	T	X	Y
8	Z	V	U

37 pin - 12 channels			
Ch	Hot	Cold	Gnd
No.	+	-	⏏
1	E	F	A
2	B	C	G
3	H	J	D
4	S	T	K
5	L	M	U
6	V	W	N
7	P	R	X
8	a	b	g
9	c	d	j
10	e	f	m
11	n	p	h
12	r	s	k

54 pin - 16 channels			
Ch	Hot	Cold	Gnd
No.	+	-	⏏
1	W	f	r
2	J	R	a
3	k	v	AC
4	E	M	V
5	e	q	y
6	B	H	P
7	Z	j	u
8	D	L	U
9	d	p	x
10	A	G	O
11	Y	h	t
12	C	K	T
13	c	n	w
14	F	N	X
15	g	s	AB
16	S	b	m

85 pin - 28 channels			
Ch	Hot	Cold	Gnd
No.	+	-	⏏
1	A	B	C
2	E	F	H
3	J	K	L
4	N	P	R
5	S	T	U
6	X	Y	Z
7	a	b	c
8	d	f	g
9	h	i	j
10	k	m	n
11	p	q	r
12	t	u	v
13	w	x	y
14	z	AA	AB
15	AC	AD	AE
16	AF	AH	AJ
17	AK	AL	AM
18	AP	AR	AS
19	AT	AU	AV
20	AW	AX	AY
21	AZ	BA	BB
22	BC	BD	BE
23	BJ	BK	BL
24	BM	BN	BP
25	BS	BT	BU
26	BV	BR	BF
27	BH	AN	s
28	W	M	D

72 pin - 24 channels							
Ch	Hot	Cold	Gnd	Ch	Hot	Cold	Gnd
No.	+	-	⏏	No.	+	-	⏏
1	3	2	1	13	44	38	37
2	5	6	7	14	41	42	43
3	9	8	4	15	45	39	40
4	13	14	10	16	48	47	46
5	15	11	12	17	52	53	49
6	18	17	16	18	54	50	51
7	22	23	19	19	57	56	55
8	24	20	21	20	61	62	58
9	27	26	25	21	63	59	60
10	33	34	28	22	69	65	64
11	30	31	32	23	66	67	68
12	36	35	29	24	72	71	70

100 pin - 32 channels							
Ch	Hot	Cold	Gnd	Ch	Hot	Cold	Gnd
No.	+	-	⏏	No.	+	-	⏏
1	1	2	3	18	52	53	54
2	4	5	6	19	55	56	57
3	7	8	9	20	58	59	60
4	10	11	12	21	61	62	63
5	13	14	15	22	64	65	66
6	16	17	18	23	67	68	69
7	19	20	21	24	70	71	72
8	22	23	24	25	73	74	75
9	25	26	27	26	76	77	78
10	28	29	30	27	79	80	81
11	31	32	33	28	82	83	84
12	34	35	36	29	85	86	87
13	37	38	39	30	88	89	90
14	40	41	42	31	91	92	93
15	43	44	45	32	94	95	96
16	46	47	48	33	97	98	99
17	49	50	51				

101 pin - 32 channels							
Ch	Hot	Cold	Gnd	Ch	Hot	Cold	Gnd
No.	+	-	⏏	No.	+	-	⏏
1	3	2	1	17	54	53	52
2	9	8	7	18	57	56	55
3	12	11	10	19	60	59	58
4	15	14	13	20	63	62	61
5	18	17	16	21	66	65	64
6	21	20	19	22	69	68	67
7	24	23	22	23	72	71	70
8	27	26	25	24	75	74	73
9	30	29	28	25	78	77	76
10	33	32	31	26	81	80	79
11	36	35	34	27	84	83	82
12	39	38	37	28	87	86	85
13	42	41	40	29	88	89	90
14	45	44	43	30	93	92	91
15	48	47	46	31	96	95	94
16	51	50	49	32	99	98	97

150 pin - 48 channels							
Ch	Hot	Cold	Gnd	Ch	Hot	Cold	Gnd
No.	+	-	⏏	No.	+	-	⏏
1	1	2	3	25	75	76	77
2	5	6	7	26	78	79	80
3	8	9	10	27	82	83	84
4	11	12	13	28	85	86	87
5	14	15	16	29	88	89	90
6	17	18	19	30	91	92	93
7	21	22	23	31	94	95	96
8	24	25	26	32	97	98	99
9	27	28	29	33	100	101	102
10	20	30	31	34	103	104	105
11	32	33	34	35	56	81	106
12	35	36	37	36	107	108	109
13	38	39	40	37	110	111	112
14	41	42	43	38	113	114	115
15	44	45	46	39	116	117	118
16	47	48	49	40	119	120	121
17	50	51	52	41	122	123	124
18	53	54	55	42	125	126	127
19	57	58	59	43	139	128	129
20	60	61	62	44	130	131	132
21	63	64	65	45	133	134	135
22	66	67	68	46	136	137	138
23	69	70	71	47	140	141	142
24	72	73	74	48	143	144	145

PART NUMBER EXPLANATION

Part N.

--	--	--	--	--	--	--	--	--	--	--	--	--	--	--	--	--	--	--	--

EXAMPLE Part N.

SVK	150	F	V	R	G	S	MP	N											
-----	-----	---	---	---	---	---	----	---	--	--	--	--	--	--	--	--	--	--	--

CONNECTOR SERIES	
SVK = (13 - 19 - 25 - 37 - 54 - 85 - 100 - 150 pin) Back shell: standard. Locking ring: ergonomic and rubber coated	SVK
SVS = (72 - 101 PIN) slim series, high density. Back shell: standard. Locking ring: ergonomic and rubber coated	SVS

CONTACTS NUMBER	
013 - 019 - 025 - 037 - 054 - 072 - 085 - 100 - 101 - 150	...

CONTACT TYPE	
M = male	M
F = female	F

CONNECTOR TYPE	
V = inline	V
P = panel	P

COUPLING TERMINATION	
- = with ramps	-
H = ergonomic locking ring with improved thickness and stronger roller pins	H
R = rubber coated locking ring	R

CONTACT PLATING TYPE	
S = silver (13 - 19 - 25 - 37 - 54 - 85 pin)	S
G = gold (13 - 19 - 25 - 37 - 54 - 72 - 85 - 100 - 101 - 150 pin)	G
N = no contact	N

CONTACT TYPE AND TERMINATION	
C = spring loaded crimp (13 - 19 - 25 - 37 - 54 - 85 pin)	C
S = spring loaded solder (13 - 19 - 25 - 37 - 54 - 85 pin)	S
P = spring loaded pcb (13 - 19 - 25 - 37 - 54 - 85 pin)	P
N = no contact	N
K = armored crimp contact (13 - 19 - 25 - 37 - 54 - 72 - 85 - 100 - 101 - 150 pin)	K
Z = armored solder contact (13 - 19 - 25 - 37 - 54 - 72 - 85 - 100 - 101 - 150 pin)	Z

CABLE CLAMP RANGE - METRIC				
Thread Size	Clamping Range (mm)	SVK (pins)	SVS (pins)	
M 20 x 1.5	6 - 12	13 - 19		MH
M 20 x 1.5	10 - 14	13 - 19		MI
M 25 x 1.5	6 - 13	25		MJ
M 25 x 1.5	13 - 18	25		ML
M 32 x 1.5	7 - 15	37 - 54	72 - 101	MN
M 32 x 1.5	11 - 21	37 - 54	72 - 101	MM
M 32 x 1.5	18 - 25	37 - 54	72 - 101	MO
M 40 x 1.5	15 - 23	85 - 100 - 150		MQ
M 40 x 1.5	19 - 28	85 - 100 - 150		MP
M 40 x 1.5	22 - 32	85 - 100 - 150		MR

CABLE CLAMP TYPE	
N = normal	N
S = spiral flex	S
R = strain relief	R

SPECIAL VERSION (upon request)	
For example: T = inserted solder termination contacts	T
Not pre-installed	0

RUBBER COATED LOCKING RING COLOR	
0 = Black (standard)	0
1 = Green	1
2 = Red	2
3 = Yellow	3
4 = Blue	4

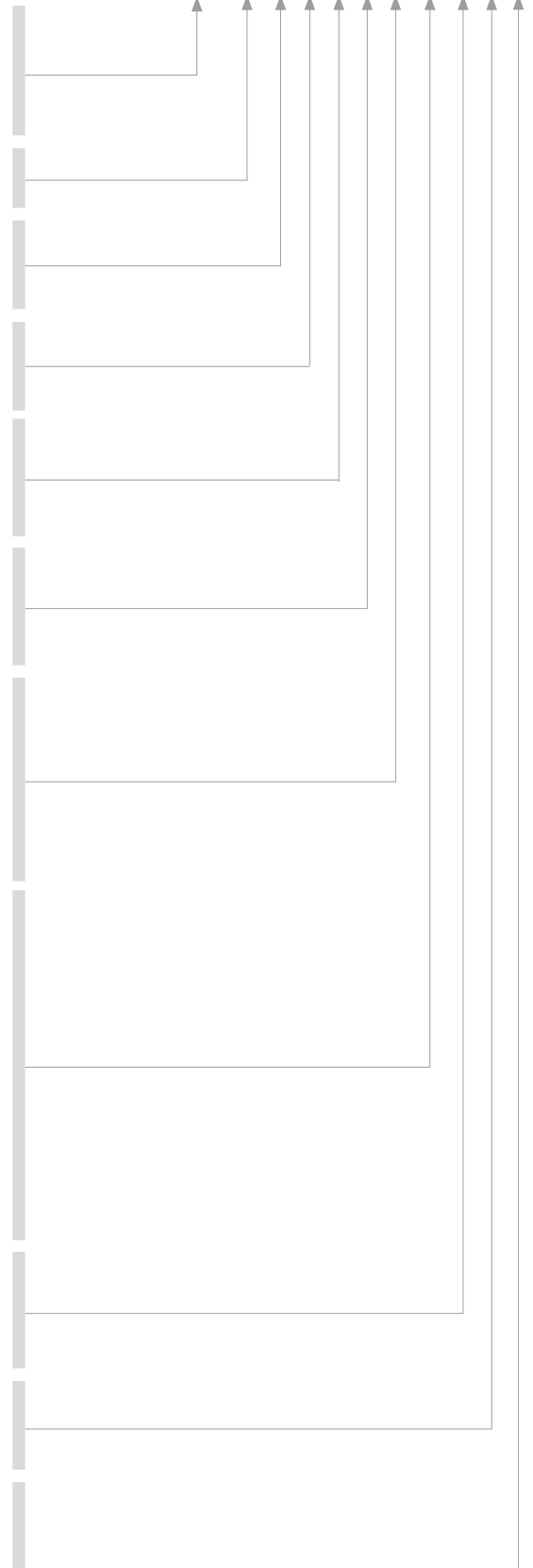

VALENTINI

www.syntaxnet.it
info@syntaxnet.it
Tel. +39 0119594160
Fax +39 0119594166
via Asti 84/A
10098 Rivoli
(TO) - ITALY

SYNTAX[®]
is a VALENTINI Trade Mark

